

Handheld videoscope

CT series

Safety Recommendations

DANGER

- This device must not be used for medical or veterinary purposes.
- Do not use this item in explosive atmospheres.
- Do not look into distal end with naked eyes, eyesight maybe harmed by strong light.

WARNING

- Keep the device out of reach of children.
- Do not try to modify or disassemble the unit.
- Do not pull hard or twist the insertion tube.
- Serious impact may bring breakage of lens components at distal end .
- Do not use or store the instrument at a temperature higher than 60° C or lower than -20° C.
- Store the instrument in dry and well ventilated environment.

Parts Function

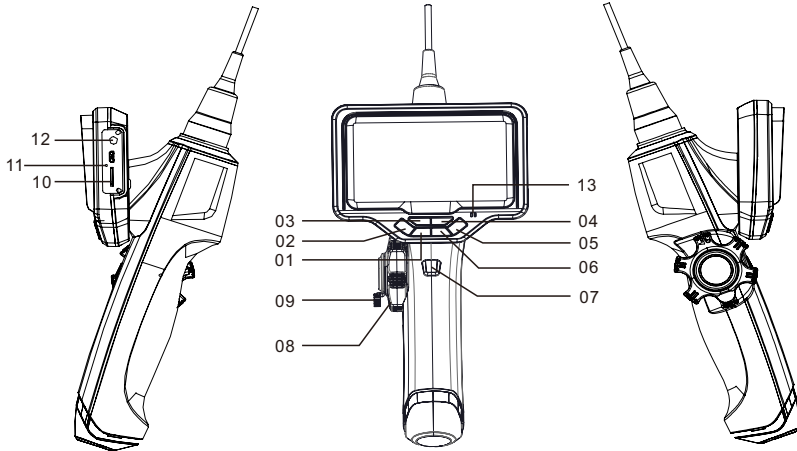

- 01 Downward Key ▼
- 02 Power On/Off 
- 03 Upward Key ▲
- 04 OK
- 05 MENU

- 06 Brightness 
- 07 Snap
- 08 Control wheel
- 09 Lock knob

- 10 Micro SD Slot
- 11 Reset
- 12 5V DC Jack
- 13 Status Indicator

Quick Setup

1. Detachable Panel

Take apart : Set Sliding key to outside with finger, then push forwards the panel which will be taken apart from main body. Fig01.

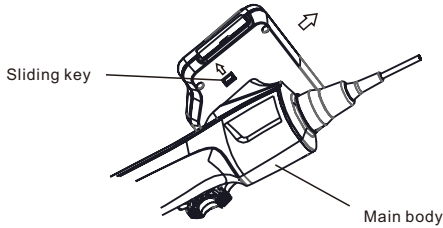

Fig01.

Combine together: align connectors between panel and main body closely, then slide the panel backwards, with a crack, the panel will be fixed on main body securely. Fig02.

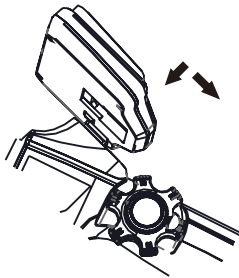
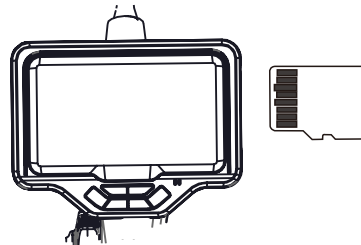

Fig02.

2. Ready for use

At shutdown status, plug in Micro SD in direction. Fig03

Fig03.





Long press button , the status indicator turns green, the device enters preview mode, real time image shows on the screen and at the same time, some icons and time information will be seen at top location. Fig04



Fig04

Through button , steer the control wheel to make distal end bending. Locking knob is used to tighten or release the control wheel in order to fix distal end at a certain angle. Fig05.

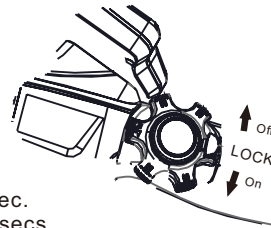

Fig05



NOTE

Definition

Press: press and release less than 1sec.

Long press: keep press for around 3 secs.

MENU set up

Switch on device and enter preview mode, press **MENU** to access menu interface, use   to select item and with **OK** to confirm.



The menu options listed as below:

- Time watermark
- Loop Record
- Recording
- Date/time
- Language
- Brightness
- Format
- Default setting
- Version
- WIFI

NOTE

By Pressing **MENU** key enable to end current menu setting job and jump to MENU interface so as to enter other items.

Time watermark

Using   to select **turn off** or **open**, with **OK** key to confirm, the **open** allows video to be recorded with time mark.

Loop Record



Video files consist of consecutive clips with the same duration, the duration is optional :

- Permanent
- 1 minute
- 3 minutes
- 5 minutes

NOTE

Permanent means the whole video is to be recorded as a single clip.

Sound Recording

Under this item, to select **open**, the surrounding sound and video will be recorded simultaneously. At the same time, the icon on the top of screen is changed from  to .

The function also can be activated by shortcut key .

Date and Time



Using   to increase or decrease the number, press OK to move to next step. Fig 06.



Fig 06.

Language

Select required language with   , Press OK to confirm the choice.

Brightness

Through this menu, you can change brightness of light on camera end, total 4 levels optional, and **off** to turn off the light.

NOTE

In most cases, you should use  key to adjust brightness more often.



Format

In some cases, micro SD card can not work properly, you can try to format the card to fix the problem. Please back up files in advance due to the data could be lost in the process.

Default setting and Version

By the two items, you can get to factory setting and see current software version.

WIFI

Select **On** or **Off** to choose the WIFI function to be activated or not, the icon on the top of screen will turn  to  that indicates the WIFI is active.

Scan QR code on the screen to load down APP onto your smart phone , you can also search **RoadCam** in android or apple store to get the APP.

To Set WLAN on your phone, find the net :wifi_camera_XXXXXXXX and join it, then open the APP, the image will be present on your phone screen.

NOTE

The function of keys on panel is disable until the wifi net is disconnected in WLAN setting on your phone.

NOTE

A separate using manual for WIFI function is available, please contact your dealer to get detailed information.

Take picture and Video recording

Take picture

In preview mode, press Snap to take a picture, the picture is stored to Micro SD card with a file name of running number.



Such as: IMG_0000002.JPG

Video recording

In preview mode, Long press Snap to take video, the video file name is related to date and time. Meanwhile, you can get snapshot during video recording process, the snapshot picture is stored with running number.

For example: VID_20210116_110110.MOV
CAP_0000002.JPG

Image viewing

In preview mode, long press MENU, the image last picture or video will present, please use   to find the image wanted. Fig07.

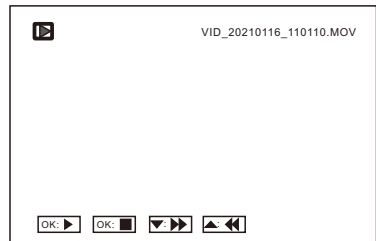
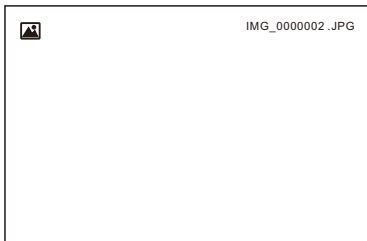

Fig07

Press **OK** to play video, press **OK** again to pause, press **OK** once more return to play.

Press **▼** to fast-forward, **▲** to back-forward, repeatedly press the key to get 2x 4x 8x speed.

Delete files

When you find targeted picture or video, press **MENU** to delete files, press **OK** to choose delete current single one or all files.

Long press **MENU**, jump to preview mode.

Storage & Maintenance

1.Rechargeable battery

Charging time around 7 hours till the indicator turn off, the fully charged battery can continuously work for 5 hours with LED ring illumination, around 2 hours for fiber illumination.

2. Cleaning components

Cleaning insertion tube

Wipe thoroughly with a piece of gauze or other material moistened with neutral detergent, next clean by gauze moistened with clear water, and then wipe the insertion tube dry off all moisture.

NOTE

Clear the insertion tube immediately after withdrawing the insertion tube. Leave the very dirty insertion tube for long periods can cause it to be corroded.

Cleaning distal end

Grasping the rigid portion of camera end, use a clean soft piece of gauze or cotton swabs to wipe off dirty and water. Best results may be obtained using commercially available absolute ethanol. Fig08.

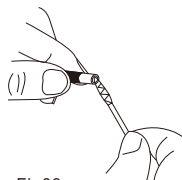

Fig08

Cleaning unit body

Wipe with soft cloth dampened with clean water, and wipe with clear and dry cloth.

3. Storage precautions

- Store the instrument under normal room temperature and humidity.
- Straighten angulation section while lay into carrying case.
- Store the equipment at a clear, dry and stable place.

Q & A

Q: No image on the screen after turning the power on

A: Battery is exhausted. connect the panel to the power adapter and recharging .

Q: Unable to take photo or record video

A: SD card absent, wrongly inserted, full or faulty.

Q: Shut down

A: When all functions freeze or fail, insert an insulated needle into the hole on the side of the main unit, restart the device to find if the problem is resolved. Fig09.

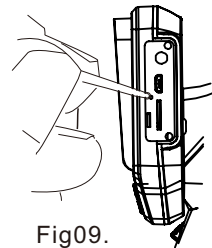

Fig09.

System parameters

Display Unit

LCD Panel	4.5" TFT LCD MicroSD Card, support 128GB
Power source	Lithium battery 6000mAh AC adapter: Input 100-240VAC 50/60Hz, Output 5VDC

Operating Environment

Operating Temperatures	Distal end and insertion tube :0-60° C	
	Other parts excepted of above :0-40°C	
Operating Humidity	15-90% RH	
Water proof	Insertion tube	Ip67
	Other parts	Ip52

Supplementary

Fiber illumination

On some devices, you can find an external radiator, Fig10. which is used to dissipate heat produced by built-in 6 Watt light source, the light is conducted to camera end by glass fiber.

WARNING

Be cautious not to touch the radiator, or the hot surface may hurt your finger.

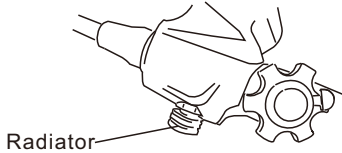

Fig 10

High temperature videoscope

Devices equipped with cooling system allow probe portion(camera and distal insertion tube) working at high temperature condition, up to 250 centigrades.

The cooler fixed to main body by screw, connect to compressed air and find that cold air should spout out from 4 holes at camera end, make sure the airflow is smooth, and keep at least 2 minutes outside before probe portion enter high temperature of objectives. The cooler splits the compressed air to cold and hot air, the cold enter the interior tunnel for use and the hot air expel out from other end. Fig11,12

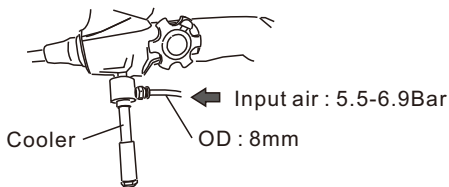

Fig11

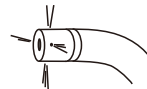

Fig12

NOTE

Keep compressed air conveying constantly during the probe portion working at high temperature condition.

The compressed air should be 5.5-6.9bar, clear and dry.

WARNING

Do not touch the cooler, the hot surface may hurt your skin.